

RCCN 日成SG型可退式尼龙铆钉 Nylon Push Latches



材质：进口UL合格之NYLON66.

防火等级:94V-2, 不易老化

用法：先将机板及被固定板钻孔, 再将本产品塞入压紧, 即可使两板相结合。

用途：PC板及机板之固定, 取代螺丝, 不需工具即可完成装配

颜色：黑色 白色

特点：容易拆卸及容易固定。

品质优良,做工精细。

Material : NYLON66, UL approved,

Fireproof: 94V-2

Good quality,easy to install

Color : black,white



单位/Unit:mm

型号/Item.No.		装配孔径 Installiny Hole		适用板厚 Suitable board thickness T1	尺寸 Dimensions				附图编号 FIG.NO.		包装
黑色/Black	白色/White	移动板孔 Movable Hole DR	固定板孔 Fixed Hole DF		W	H	L	T	顶部 Head	底部 Bottom	Packing
SGSL-SPLSLB	SGSL-SPLSLW	7.5-7.7	8.0-8.2	1.5-3.7	10.8	2.0	8.6	1.1	1	A	1000PCS
SG1L-SPL1LB	SG1L-SPL1LW	7.5-7.7	8.0-8.2	2.0-4.2	10.8	2.0	9.0	1.6	1	A	
SG2L-SPL2LB	SG2L-SPL2LW	7.5-7.7	8.0-8.2	3.0-5.2	10.8	2.0	10.0	2.5	1	A	
SG3L-SPL3LB	SG3L-SPL3LW	7.5-7.7	8.0-8.2	4.6-6.9	10.8	2.0	11.7	4.1	1	A	
SG4L-SPL4LB	SG4L-SPL4LW	7.5-7.7	8.0-8.2	5.8-8.1	10.8	2.0	12.9	5.3	1	A	
SGSL-SPB1LB	SGSL-SPB1LW	7.5-7.7	8.0-8.2	1.5-3.7	10.8	2.0	8.6	1.1	2	B	
SG1L-SPB1MB	SG1L-SPB1MW	7.5-7.7	8.0-8.2	2.0-4.2	10.8	2.0	9.0	1.6	2	B	
SG2L-SPB2MB	SG2L-SPB2MW	7.5-7.7	8.0-8.2	3.0-5.2	10.8	2.0	10.0	2.5	2	B	
SG3L-SPB3MB	SG3L-SPB3MW	7.5-7.7	8.0-8.2	4.6-6.9	10.8	2.0	11.7	4.1	2	B	
SG4L-SPB4MB	SG4L-SPB4MW	7.5-7.7	8.0-8.2	5.8-8.1	10.8	2.0	12.9	5.3	2	B	
SG1M-SPB1MB	SG1M-SPB1MW	5.9-6.1	6.3-6.5	1.5-3.7	8.5	1.8	8.0	1.1	3	C	
SG2M-SPB2MB	SG2M-SPB2MW	5.9-6.1	6.3-6.5	2.0-4.2	8.5	1.8	8.5	1.6	3	C	
SG3M-SPB3MB	SG3M-SPB3MW	5.9-6.1	6.3-6.5	3.0-5.2	8.5	1.8	9.5	1.8	3	C	
SG4M-SPB4MB	SG4M-SPB4MW	5.9-6.1	6.3-6.5	4.6-6.9	8.5	1.8	11.0	1.8	3	C	
SG1S-SPB1SB	SG1S-SPB1SW	4.6	4.8	1.5-3.7	6.5	1.2	7.6	1.0	4	D	
SG2S-SPB2SB	SG2S-SPB2SW	4.6	4.8	2.0-4.2	6.5	1.2	8.1	1.5	4	D	

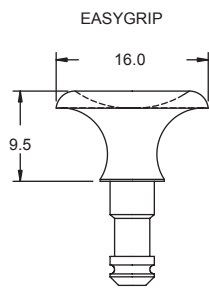
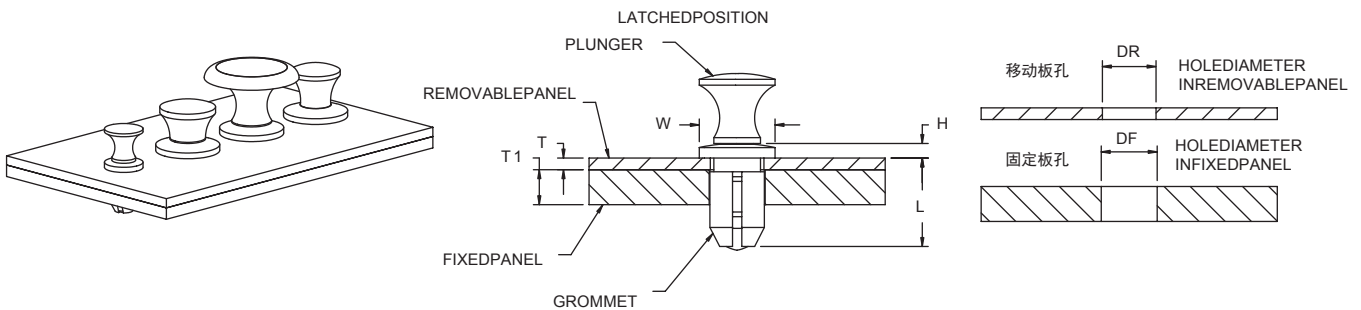

FIG.1

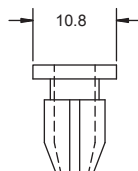

FIG.A

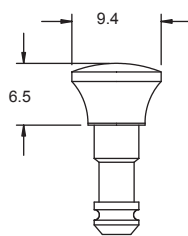

FIG.2

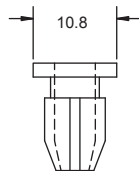

FIG.B

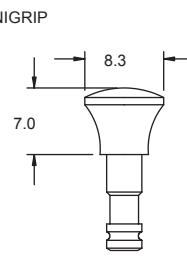

FIG.3

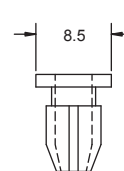

FIG.C

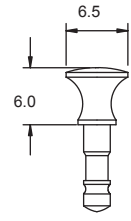

FIG.4

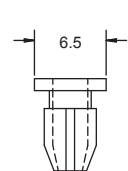

FIG.D